

FLO

MOOME COLLECTION



FLO

PRODUCT INFORMATION

FLO model is only available in 7x pre-selected fabric combinations and 11 different base finishes.

COM or Leather is not possible for this model.

FINISH FABRIC COMBO OPTIONS:

GREY BLACK

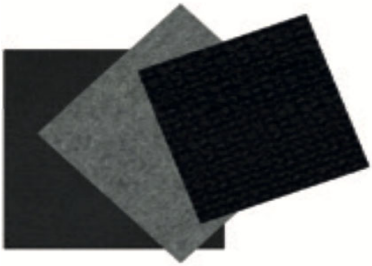

BEIGE

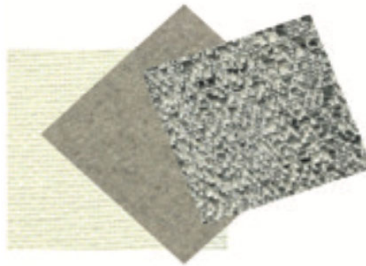

BLUE

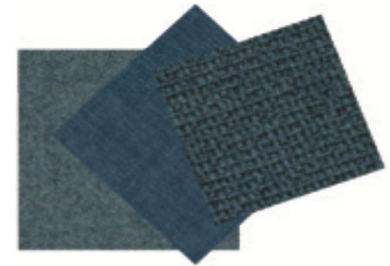

YELLOW

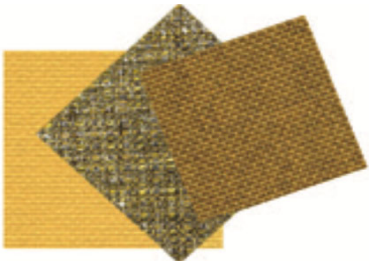

GREEN



ORANGE

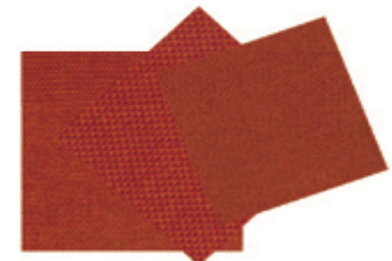

WARM RED



FLO

PRODUCT INFORMATION

WOOD FINISH OPTIONS:



NAI - Natural



OIL A



GMI



MEI - Medium oak



ZAI - Grey oak (sand)



LEI - Loam oak oil



GRI - Grey oak matt lacquered

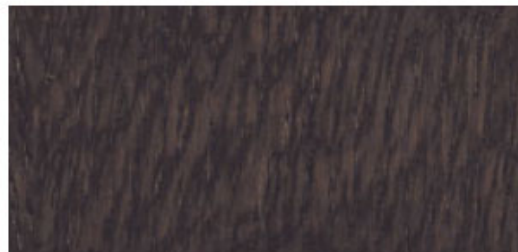

DGI - Dark Grey



TWI - Medium Brown

FLO

PRODUCT INFORMATION

WOOD FINISH OPTIONS:



WEI - Wenge



ZWI - Black

DIMENSIONS IN CM

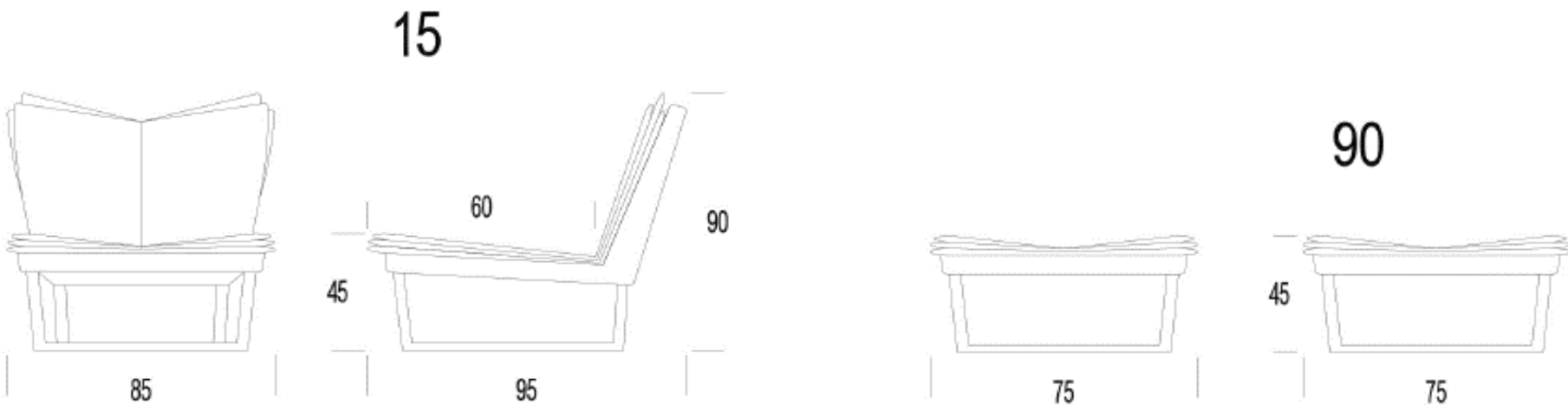

FLO

CHAIR

H: 35 1/2"

SH: 17 3/4"

D: 37 1/2"

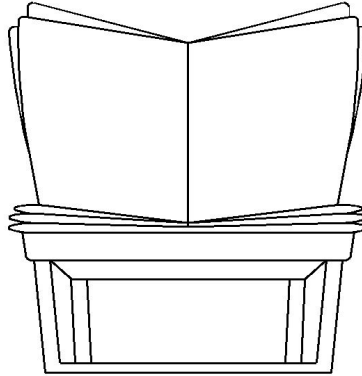

W:

33 1/2

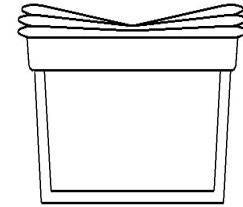

29 1/2

| | | |
|---------------------|------------------|---------|
| Article Code | 15 | 90 |
| Description | Upholstered Arms | Ottoman |

| | |
|--|--|
| Fabric | |
| GREY/BLACK BEIGE BLUE YELLOW GREEN ORANGE WARM RED | |