

LOU



LOU

PRODUCT INFORMATION

METAL FEET: STANDARD OPTIONS ARE PO3-180ZW / PO3-200-ZW/ PO11/200/ZW - COLOR RAL 9005

UPCHARGE FOR DIFFERENT RAL COLOR =

WOODEN FEET: OPTION WITHOUT UPCHARGE

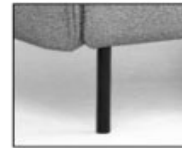

PO3-180
PO3-200

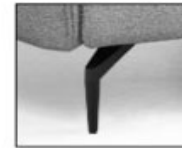

PO11-180
PO11-200

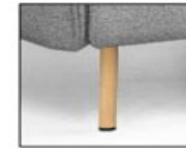

HTP7-180
HTP7-200

ITEMS -35/37/38/39:

ADDITIONAL SUPPORTING LEG WILL BE PROVIDED DUE TO SPAN IN LENGTH

FINISH OPTIONS

possible RAL-colours:



beech, possible wood colours:



NOT AVAILABLE IN LEATHERS:

W401XX, W429XX , W477XX, W510XX,
W618XX

LOU

PRODUCT INFORMATION

DIMENSIONS IN CM

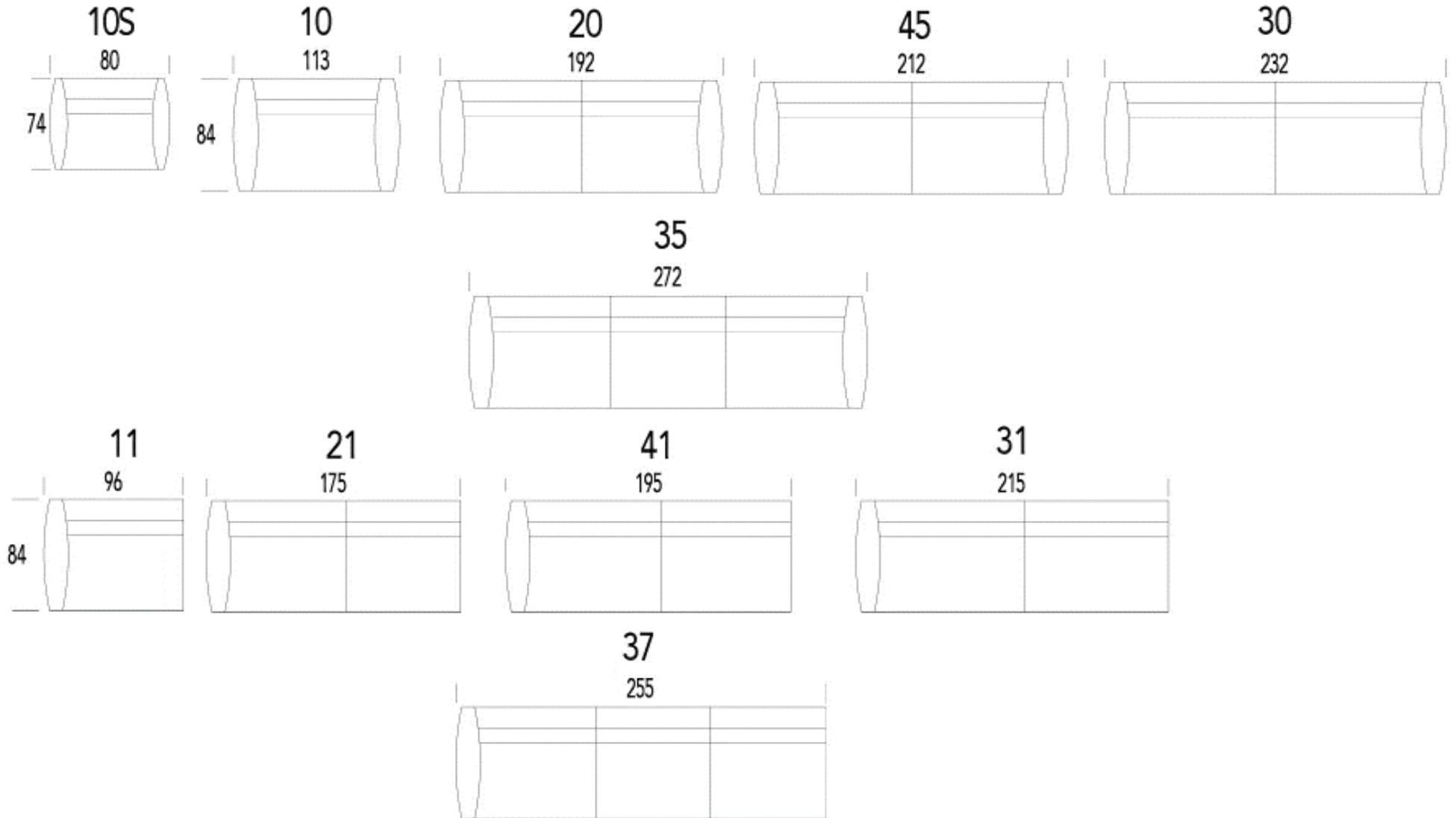

LOU

PRODUCT INFORMATION

DIMENSIONS IN CM

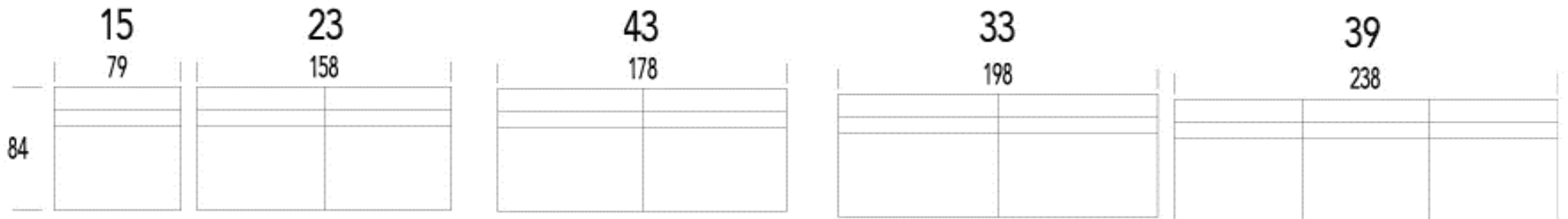
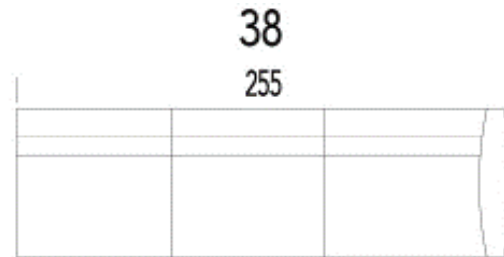
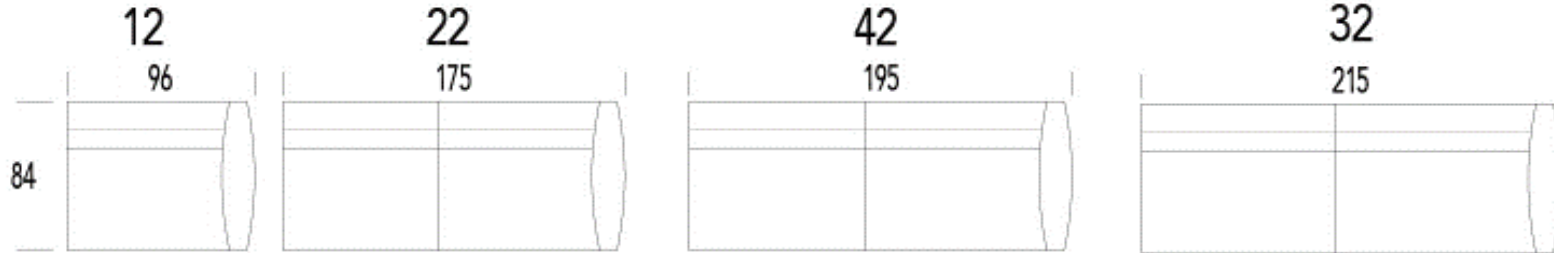

LOU

PRODUCT INFORMATION

DIMENSIONS IN CM

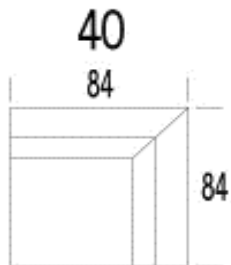
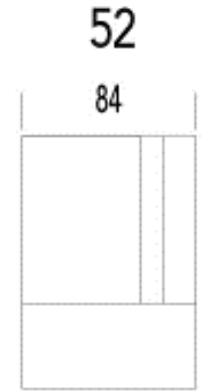
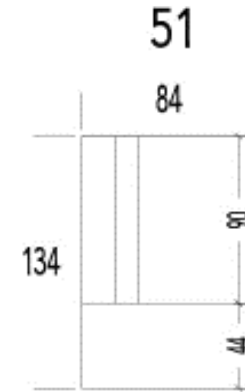
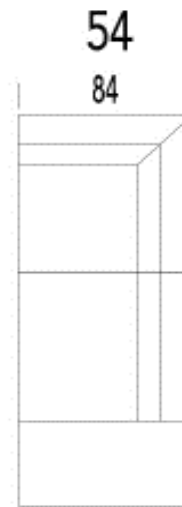
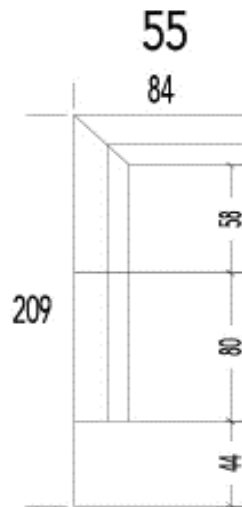
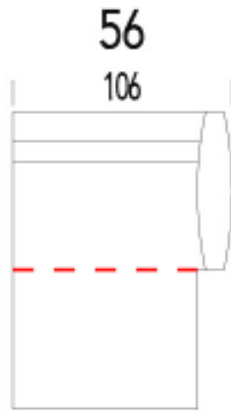
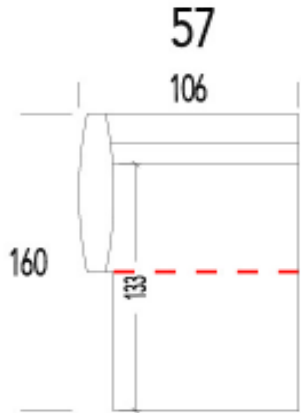

91-92-93-94

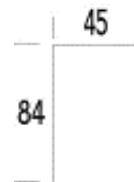

90

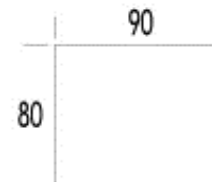

leather seams

LOU

PRODUCT INFORMATION

DIMENSIONS IN CM

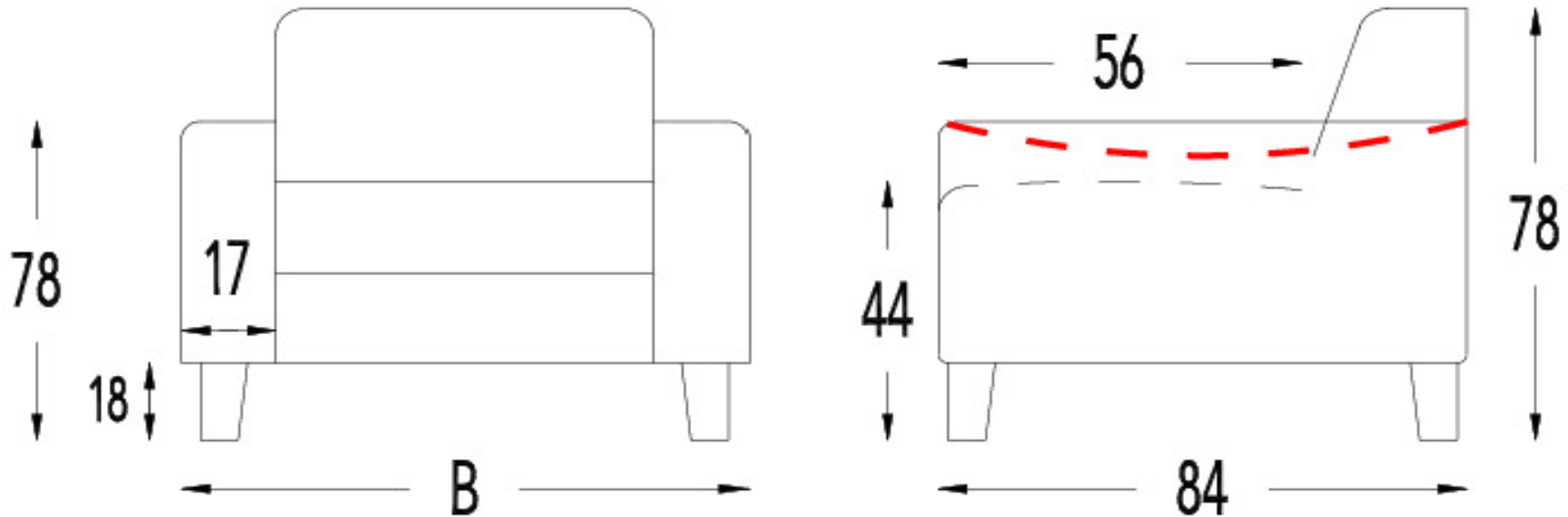

(Tolerance on dimensions $\pm 3\%$)

leather seams

LOU

H: 30 3/4"
SH: 17 3/8"
D: 33"

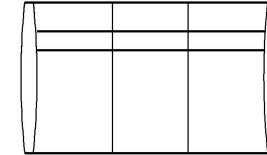
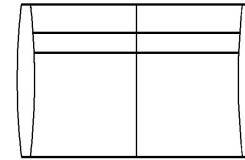
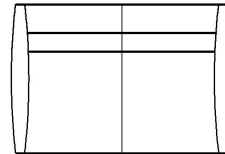
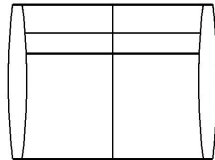
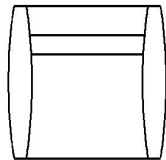
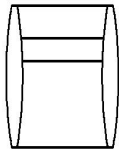

W: 31 1/2

44 1/2

75 1/2

83 1/2

91 1/2

107

H: 32 1/4" D: 29 1/8"

Article Code	10S	10	20	45	30	35
Description	Small Chair	Chair	Small 2 Seater	Medium 2 Seater	Large 2 Seater	3 Seater

COM Yardage	4.57	5.05	7.34	7.58	7.58	8.06
-------------	------	------	------	------	------	------

Fabric						
COM ST02 (ONLY TB117 FABRICS)						

COL Sqft	74.27	99.03	130.03	139.93	210.43	173.30
----------	-------	-------	--------	--------	--------	--------

Leather						
COL W4 W5 W6						

NOT AVAILABLE IN LEATHERS:

W401XX, W429XX , W477XX, W510XX, W618XX

LOU

H: 30 3/4"
SH: 17 3/8"
D: 33"

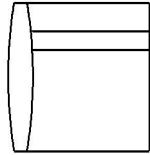

W: 38

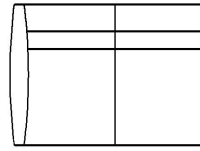

69

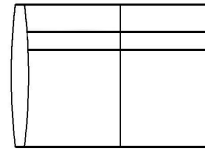

77

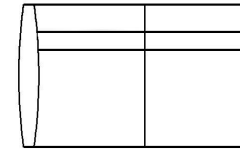

84 1/2

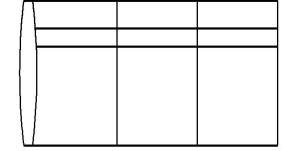

100 1/2

Article Code	11/12	21/22	41/42	31/32	37/38
Description	11- LAF Chair 12-RAF Chair	21- Left Arm Small 2 Seater 22-Right Arm Small 2 Seater	41- Left Arm Medium 2 Seater 42-Right Arm Medium 2 Seater	31- Left Arm Large 2 Seater 32-Right Arm Large 2 Seater	37- Left 3 Seater 38-Right 3 Seater

COM Yardage	3.85	6.01	6.38	6.89	6.89
-------------	------	------	------	------	------

Fabric	
COM ST02 (ONLY TB117 FABRICS)	

COL Sqft	74.27	111.41	117.65	126.26	148.54
----------	-------	--------	--------	--------	--------

Leather	
COL W4 W5 W6	

NOT AVAILABLE IN LEATHERS:

W401XX, W429XX , W477XX, W510XX, W618XX

LOU

H: 30 3/4"
SH: 17 3/8"
D: 33"

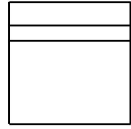

W: 31

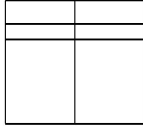

62

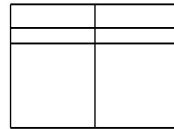

70

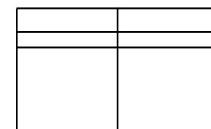

78

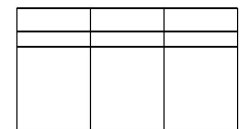

93 1/2

Article Code	15	23	43	33	39
Description	Armless Single Element	Armless Small 2 Seater Element	Armless Medium 2 Seater Element	Armless Large 2 Seater Element	Armless 3 Seater Element

COM Yardage	3.25	4.81	5.41	6.01	6.01
-------------	------	------	------	------	------

Fabric	
COM	
ST02 (ONLY TB117 FABRICS)	

COL Sqft	61.89	84.17	94.08	105.27	123.78
----------	-------	-------	-------	--------	--------

Leather	
COL	
W4	
W5	
W6	

NOT AVAILABLE IN LEATHERS:

W401XX, W429XX, W477XX, W510XX, W618XX

LOU

H: 30 3/4"

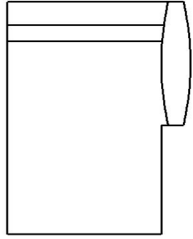

W: 41 1/2
D: 63"

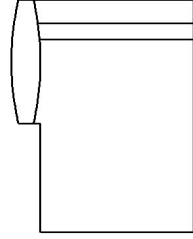

W: 41 1/2
D: 63"

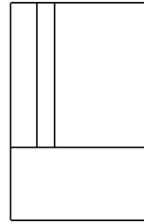

W: 33
D: 52 3/4"

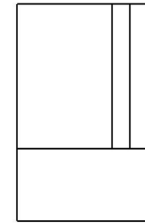

W: 33
D: 52 3/4"

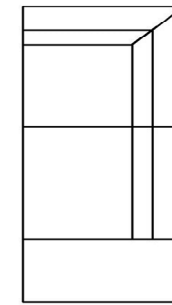

W: 41 1/2
D: 82 1/4"

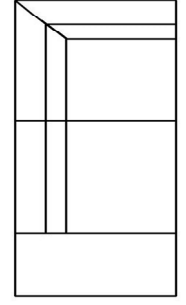

W: 41 1/2
D: 82 1/4"

Article Code	56	57	51	52	54	55
Description	56- Right Arm Chaise	57- Left Arm Chaise	51 -Left Side Add-On Bumper End	52 -Right Side Add-On Bumper End	54-Right Side Corner Chaise	55- Left Side Corner Chaise

COM Yardage	5.41	5.41	4.21	4.21	7.82	7.82
-------------	------	------	------	------	------	------

Fabric	
COM ST02 (ONLY TB117 FABRICS)	

COL Sqft	99.03	99.03	76.75	76.75	136.16
----------	-------	-------	-------	-------	--------

Leather	
COL W4 W5 W6	

NOT AVAILABLE IN LEATHERS:

W401XX, W429XX , W477XX, W510XX, W618XX

LOU

CORNER
H: 30 3/4"
SH: 17 3/8"

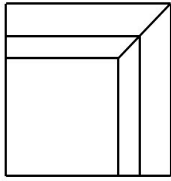

W:

33



35 1/2

H:17 3/8" D: 35 1/2"



17 1/2

H:17 3/8" D: 33"



17 1/2

H:17 3/8" D: 33"

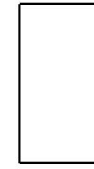

17 1/2

H:17 3/8" D: 33"

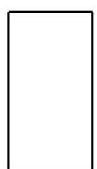

17 1/2

H:17 3/8" D: 33"

Article Code	40	90	94	91	92	93
Description	Corner	Ottoman	Ottoman	Add-On Ottoman meant to go in between seats	Add-On Ottoman meant to go on RIGHT side of seat	Add-On Ottoman meant to go on LEFT side of seat

COM Yardage	3.13	2.41	2.41	2.41	2.41	2.41
-------------	------	------	------	------	------	------

Fabric						
COM ST02 (ONLY TB117 FABRICS)						

COL Sqft	74.27	37.14	37.14	37.14	37.14	37.14
----------	-------	-------	-------	-------	-------	-------

Leather						
COL W4 W5 W6						

NOT AVAILABLE IN LEATHERS:

W401XX, W429XX , W477XX, W510XX, W618XX