

LUV

INDERA COLLECTION



LUV

PRODUCT INFORMATION

TABLES: STANDARD IN SOLID OAK

TABLES: UPCHARGE FOR MABLE OPTIONS

MARBLE - NERO MARQUINA / CARRARA / MARRON IMPERADOR / IMPERADOR LIGHT GRAY

ELEMENT 70:

ELEMENT 71:

ELEMENT 75:

MARBLE - CALCATTA ORO

ELEMENT 70:

ELEMENT 71:

ELEMENT 75:

ELEMENTS 70/71: DRAWER UPHOLSTERED IN LEATHER WW15900XX

ELEMENTE 76T/93T: LUMBAR CUSHION IS INCLUDED

PUSH BUTTONS: STANDARD VERSIONS COMES WITH 4 TOUCH BUTTONS (1 PER MOTOR)

RF CONTROL: REMOTE CONTROL WILL ALWAYS BE COMBINED WITH THE STANDARD 4 TOUCH BUTTONS

UPCHARGE FOR REMOTE:

BATTERY PACK : THE BATTERY PACK IS ALWAYS COMBINED WITH 8 BUTTONS (2 PER MOTOR). CHARGING IS DONE AT THE BACK OF THE SOFA AT THE BOTTOM VIA CABLE

UPCHARGE FOR BATTERY PACK:

BATTERY & RF CONTROL (REMOTE) CANNOT BE COMBINED**



LUV

PRODUCT INFORMATION

BATTERY PACK TECHNICAL INFORMATION

1. SAFETY INSTRUCTIONS:

- Ambient temperature 0°C – 40°C
- Handle battery carefully!
 - Do not throw, drop or subject to strong vibrations
 - Do not expose to fire
 - Do not disassemble
 - Do not submerge in water
 - Keep away from children
 - Use in a dry, well-ventilated area

2. INITIAL USE

Fully charge the battery before using it for the first time. Charging time is +/- 8 hours. The battery is fully charged when the green led turns on.

3. LOAD

Charge the battery only with the supplied transformer.
Flashing red LED light: the battery is charging
Green LED light on permanently: battery fully charged
Red LED light permanently on: battery defective

Attention:

- When charging the battery of your relax chair, always connect the battery (via the charging point) to the transformer first. Then connect the transformer to the mains.
- After charging, first disconnect the transformer from the mains, then from the battery.
- Charging should be done after the battery beeps, not before.
- The battery should be fully charged every three months. Otherwise, it will become defective and the warranty is void.
- Charging should only take place at an ambient temperature between 0 ° C and 40 ° C.
- An 8 hour charge time is recommended.
- If the battery is not fully charged after 24 hours, replace the battery.
- After 3 months of storage (not in use), fully charge the battery.

4. MAINTENANCE

On regular basis:

- Remove dust and dirt with a slightly damp cloth
- Visual inspection for damage

5. WARRANTY

Warranty battery and transformer = 2 years

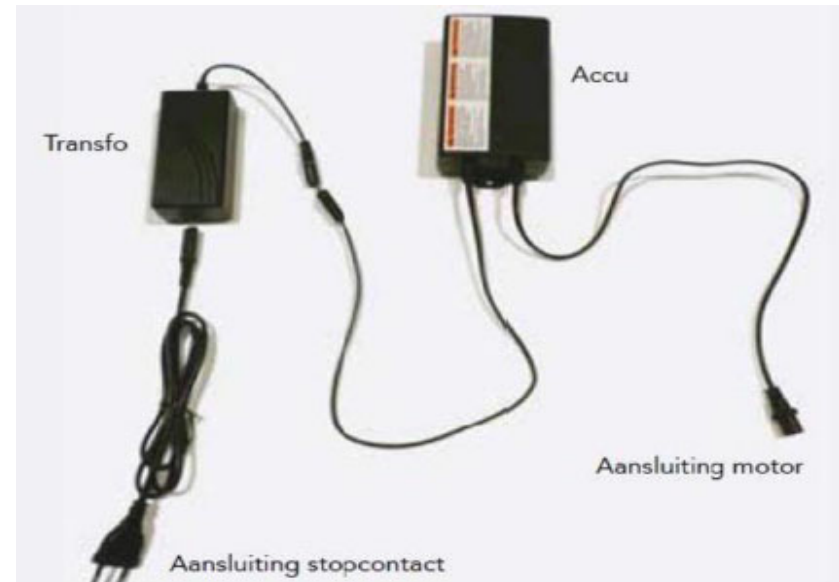

LUV

PRODUCT INFORMATION

FINISH NOTES

NOT AVAILABLE IN LEATHERS:

W401XX

W429XX

W477XX

W510XX

[CLICK TO VIEW FABRICS & LEATHERS](#)

LUV

PRODUCT INFORMATION

WOOD FINISH OPTIONS FOR TABLE



NAI - Natural



OIL A



GMI



WEI - Wenge



MEI - Medium oak



ZAI - Grey oak (sand)



LEI - Loam oak oil



ZWI - Black



GRI - Grey oak matt lacquered

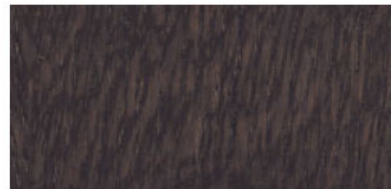

DGI - Dark Grey



TWI - Medium Brown

LUV

PRODUCT INFORMATION

MARBLE FINISH OPTIONS FOR TABLE

MAR-C
Carrara



MAR-CALDO
Calacatta d'Oro



MAR-MI
Marron
Emperador



MAR-NM
Nero Marquina



LUV

PRODUCT INFORMATION

DIMENSIONS IN CM

ARMS

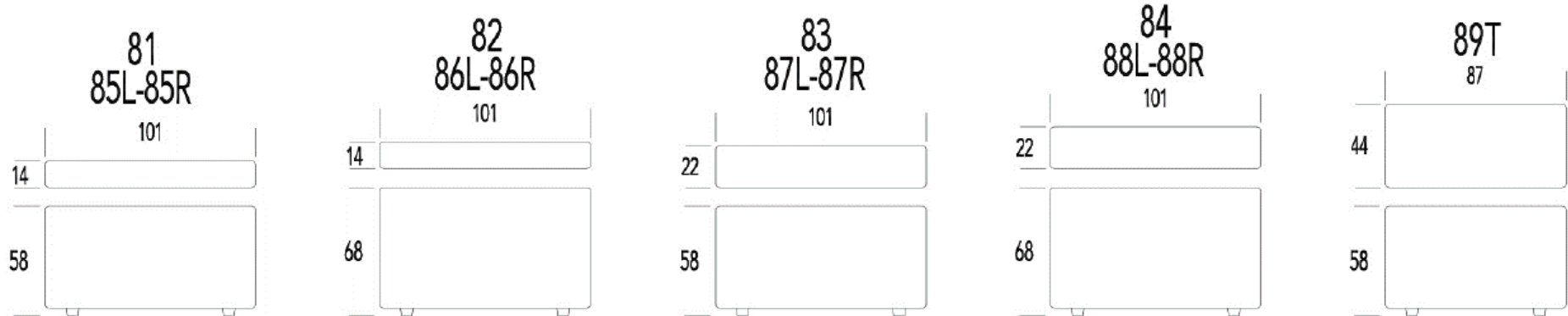

BACK REST FOR FIXED SEATS

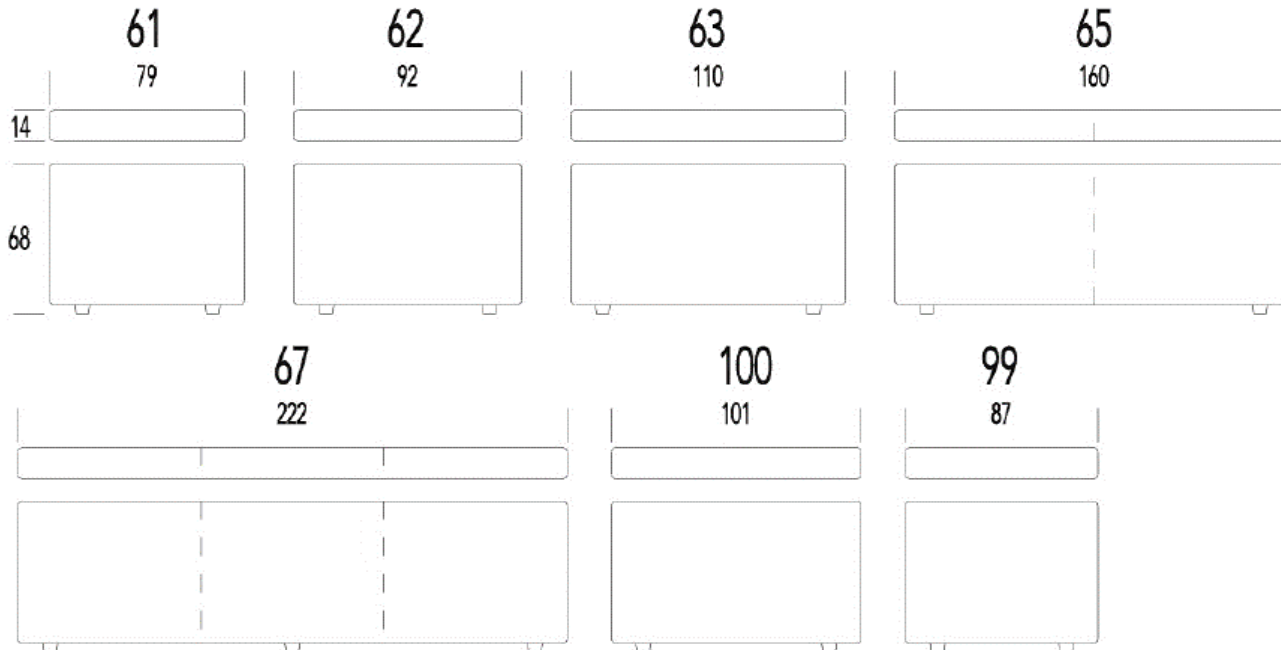

LUV

PRODUCT INFORMATION

DIMENSIONS IN CM

FIXED SEATS

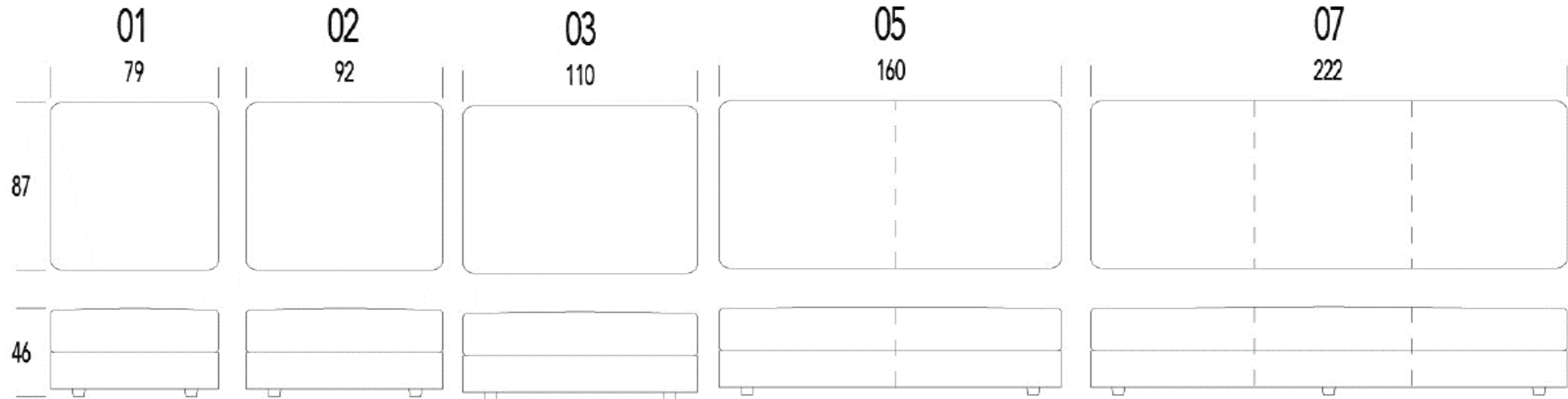

MOTORIZED SEATS

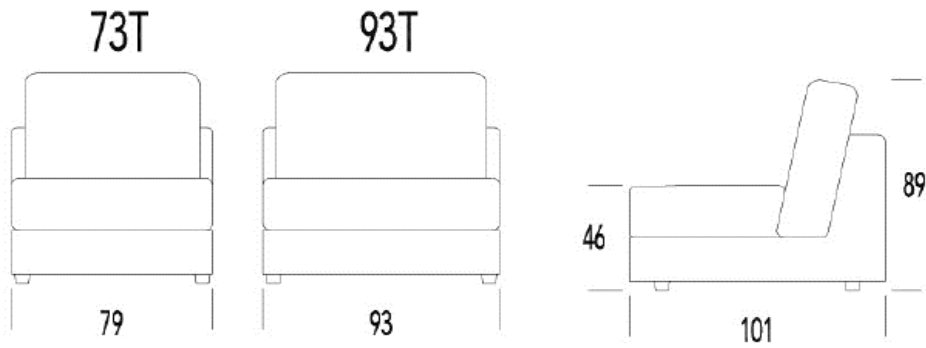

LUV

PRODUCT INFORMATION

DIMENSIONS IN CM

BACK CUSHION

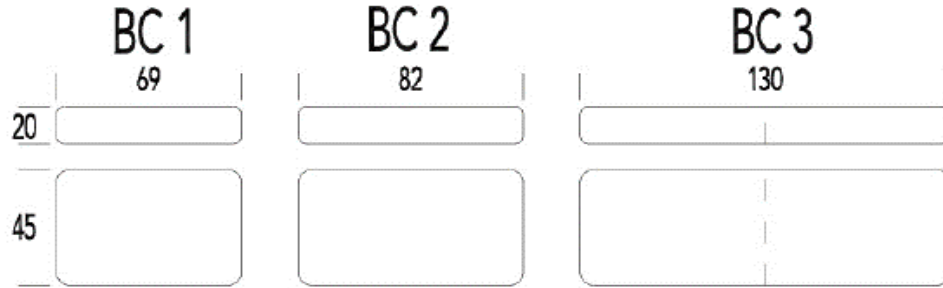

LUMBAR PILLOW

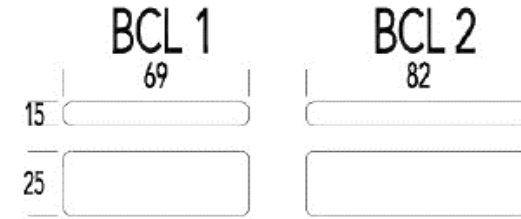

TABLES

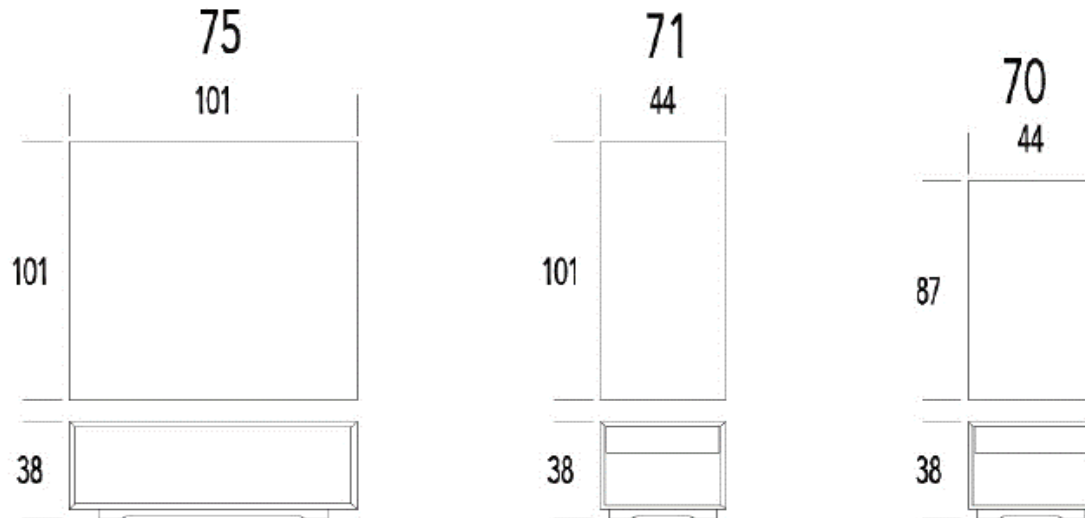

LUV

PRODUCT INFORMATION

DIMENSIONS IN CM

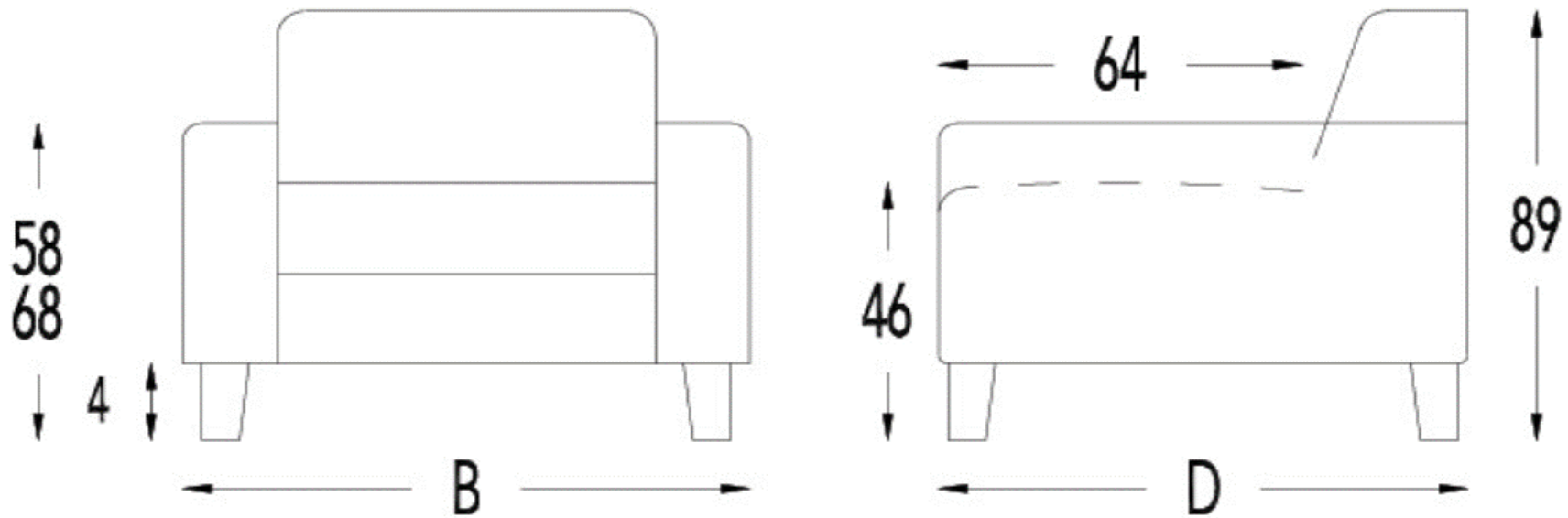

(Tolerance on dimensions $\pm 3\%$)

LUV

H: 25 5/8"



W x D: 139" x 144 1/2"

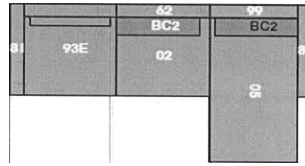

117 3/4" X 68 1/2"

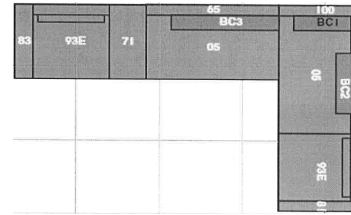

165" x 110 1/4"

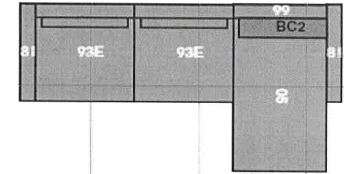

117 3/4" X 68 1/2"

Article Code	Predesigned	Predesigned	Predesigned	Predesigned
Description	88L + 93T + 71 + 62 + 02 + BC2 + 100 + 05 + 65 + BC1 + BC2 + 93T + 05 + 99 + 65 + BC2	85L + 93T + 02 + 62 + BC2 + 05 + 99 + 81 + BC2	87L + 93T + 71 + 05 + 65 + BC3 + 05 + 100 + 65 + BC1 + BC2 + 93T	85L + 93T + 93T + 05 + 99 + 81 + BC2

COM Yardage	52.46	27.12	41.84	25.75
-------------	-------	-------	-------	-------

Fabric	
COM	
ST03	
ST05	
ST06	
ST07	
ST08	
ST09	

COL Sqft	920.53	489.33	762.08	472.64
----------	--------	--------	--------	--------

Leather	
COL	
W4	
W6	
WW11	
WW15	

NOT AVAILABLE IN LEATHERS:

W401XX, W429XX, W477XX, W510XX

LUV

H: 18 1/8"
D: 34 1/4"

W: 30 1/2 36 43 1/2 63 87 1/2

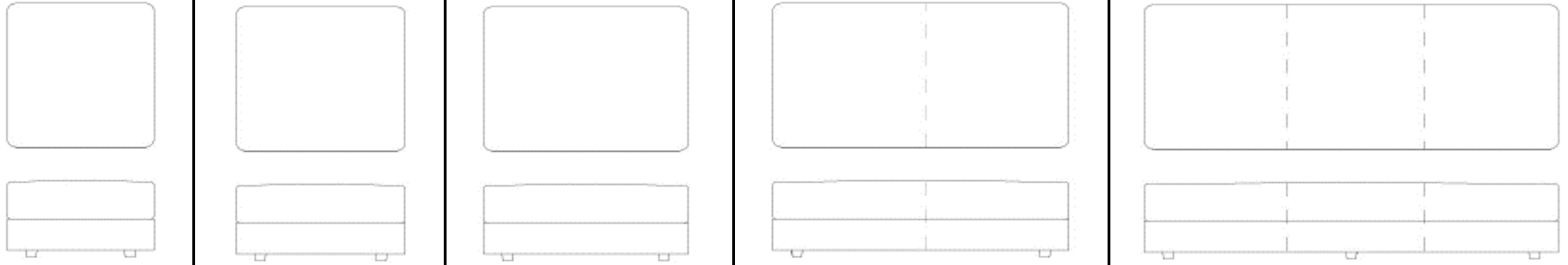

Article Code	01	02	03	05	07
Description	Fixed Seat	Fixed Seat	Fixed Seat	Fixed Seat	Fixed Seat

COM Yardage	3.74	4.13	4.66	6.10	6.10
-------------	------	------	------	------	------

Fabric	
COM	
ST03	
ST05	
ST06	
ST07	
ST08	
ST09	

COL Sqft	69.53	76.64	86.33	121.09	157.80
----------	-------	-------	-------	--------	--------

Leather	
COL	
W4	
W6	
WW11	
WW15	

NOT AVAILABLE IN LEATHERS:

W401XX, W429XX, W477XX, W510XX

LUV

H: 26 3/4"
D: 5 1/2"

W: 30 1/2 34 1/2 36 40 43 1/2 63 87 1/2

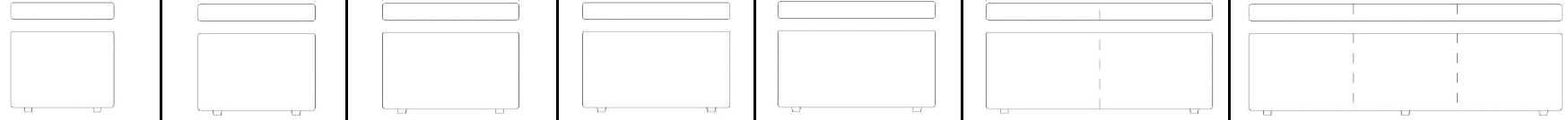

Article Code	61	99	62	100	63	65	67
Description	Back for Fixed Seat	Back for Fixed Seat	Back for Fixed Seat	Back for Fixed Seat	Back for Fixed Seat	Back for Fixed Seat	Back for Fixed Seat

COM Yardage	2.14	2.33	2.45	2.69	2.92	4.12	5.61
-------------	------	------	------	------	------	------	------

Fabric	
COM ST03 ST05 ST06 ST07 ST08 ST09	

COL Sqft	26.05	32.40	34.01	37.14	48.01	67.81	115.17
----------	-------	-------	-------	-------	-------	-------	--------

Leather	
COL W4 W6 WW11 WW15	

NOT AVAILABLE IN LEATHERS:

W401XX, W429XX, W477XX, W510XX

LUV



W: 5 1/2
H: 22 7/8" D: 40"



W: 5 1/2
H: 26 3/4" D: 40"



W: 8 1/2
H: 22 7/8" D: 40"



W: 8 1/2
H: 26 3/4" D: 40"



W: 17 1/2
H: 22 7/8" D: 34 1/4"

Article Code	81	82	83	84	89T
Description	Low Narrow Armrest for Fixed Seating	High Narrow Armrest for Fixed Seating	Low Wide Armrest for Fixed Seating	High Wide Armrest for Fixed Seating	Low Wedge Arm In Between Fixed Seating

COM Yardage	1.64	2.73	1.84	2.92	2.23
-------------	------	------	------	------	------

Fabric	
COM	
ST03	
ST05	
ST06	
ST07	
ST08	
ST09	

COL Sqft	32.18	37.14	35.95	41.12
----------	-------	-------	-------	-------

Leather	
COL	
W4	
W6	
WW11	
WW15	

NOT AVAILABLE IN LEATHERS:

W401XX, W429XX, W477XX, W510XX

LUV

H: 35"
D: 40"



W: 31

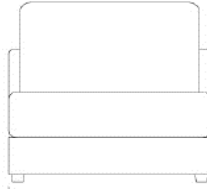

36 1/2



40
H: 15" D: 40"



17 1/2
H: 15" D: 40"



17 1/2
H: 15" D: 34 1/4"

Article Code	73T	93T	75	71	70
Description	Motorized Reclining Armless Single Seat	Motorized Reclining Armless Single Seat	Table	Table w/ Drawer	Table w/ Drawer

COM Yardage	5.75	6.42	-	-	-
-------------	------	------	---	---	---

Fabric	
COM	
ST03	
ST05	
ST06	
ST07	
ST08	
ST09	

COL Sqft	103.44	116.25	-	-	-
----------	--------	--------	---	---	---

Leather	
COL	
W4	
W6	
WW11	
WW15	

NOT AVAILABLE IN LEATHERS:

W401XX, W429XX, W477XX, W510XX

LUV



W: 5 1/2
H: 22 7/8" D: 40"



5 1/2
H: 26 3/4" D: 40"



8 1/2
H: 22 7/8" D: 40"



8 1/2
H: 26 3/4" D: 40"

Article Code	85L/85R	86L/86R	87L/87R	88L/88R
Description	Low Narrow Armrest for Reclining Seating (Left & Right)	High Narrow Armrest for Reclining Seating (Left & Right)	Low Armrest for Reclining Seating (Left & Right)	High Armrest for Reclining Seating (Left & Right)

COM Yardage	1.64	2.73	1.84	2.92
-------------	------	------	------	------

Fabric	
COM ST03 ST05 ST06 ST07 ST08 ST09	

COL Sqft	32.18	37.14	35.95
----------	-------	-------	-------

Leather	
COL W4 W6 WW11 WW15	

NOT AVAILABLE IN LEATHERS:

W401XX, W429XX, W477XX, W510XX

LUV



W: 27
H: 17 3/4" D: 7 7/8"

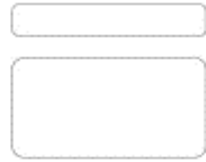

32 1/2
H: 17 3/4" D: 7 7/8"



51
H: 17 3/4" D: 7 7/8"



27
H: 9 7/8" D: 6"



32 1/2
H: 9 7/8" D: 6"

Article Code	BC1	BC2	BC3	BCL1	BCL2
Description	Back Cushion	Back Cushion	Back Cushion	Lumbar Pillow	Lumbar Pillow

COM Yardage	1.04	1.20	1.78	0.89	0.89
-------------	------	------	------	------	------

Fabric	
COM	
ST03	
ST05	
ST06	
ST07	
ST08	
ST09	

COL Sqft	22.07	22.28	34.34	9.26	10.87
----------	-------	-------	-------	------	-------

Leather	
COL	
W4	
W6	
WW11	
WW15	

NOT AVAILABLE IN LEATHERS:

W401XX, W429XX, W477XX, W510XX