

# RUSCO I 0105

## Designed for KELVIN GIORMANI

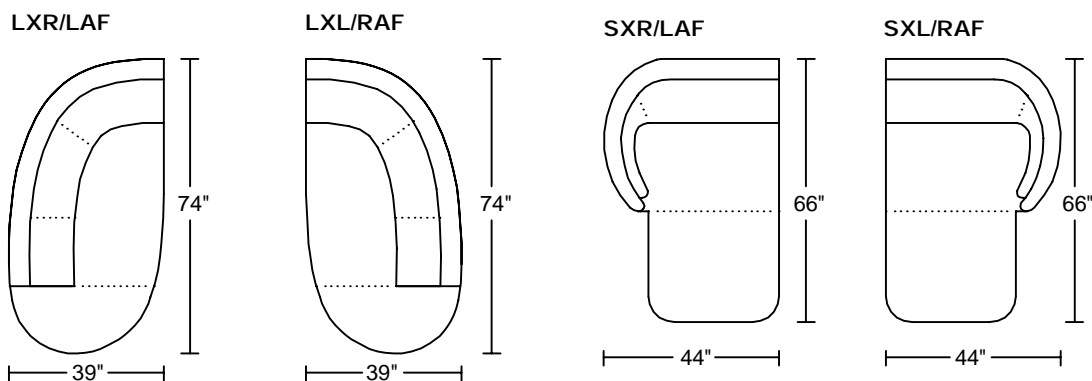
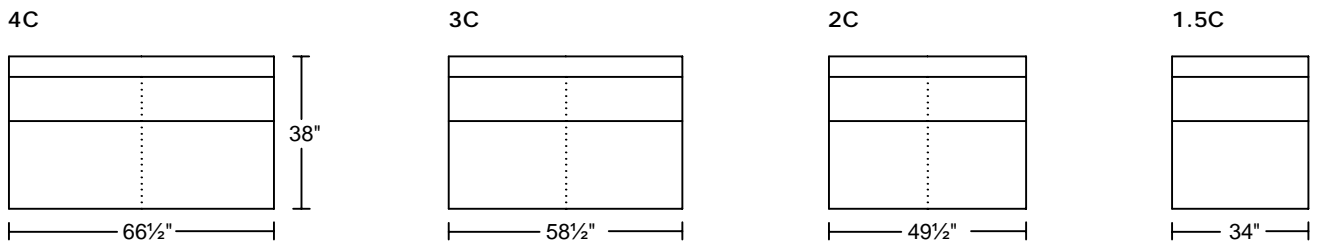
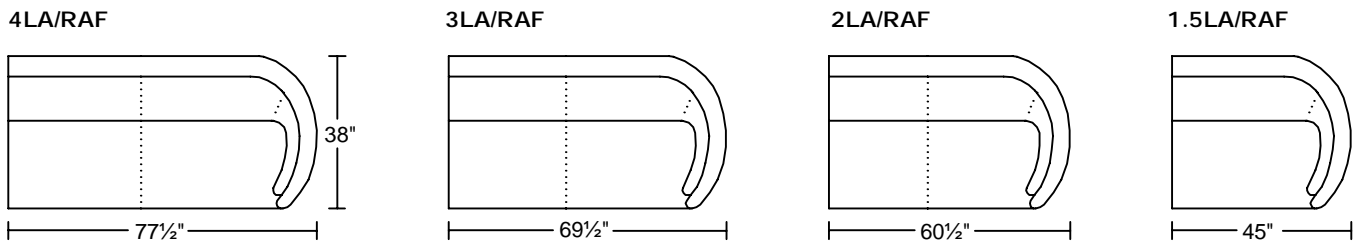
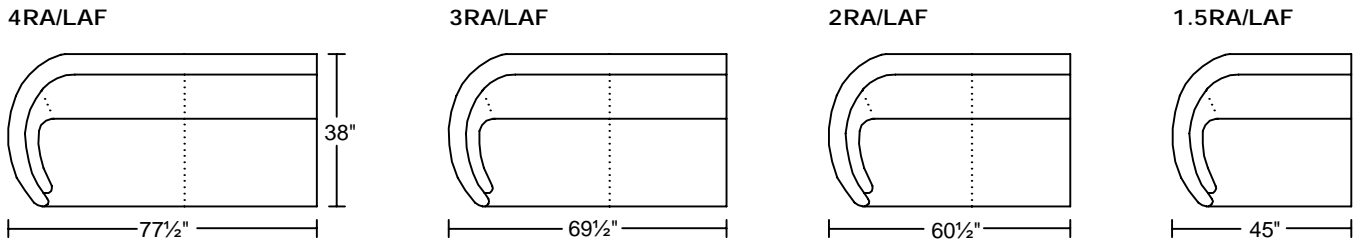
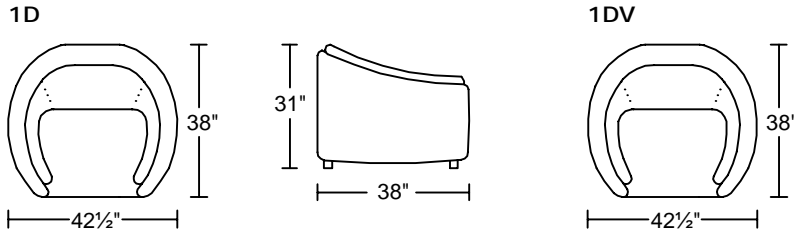
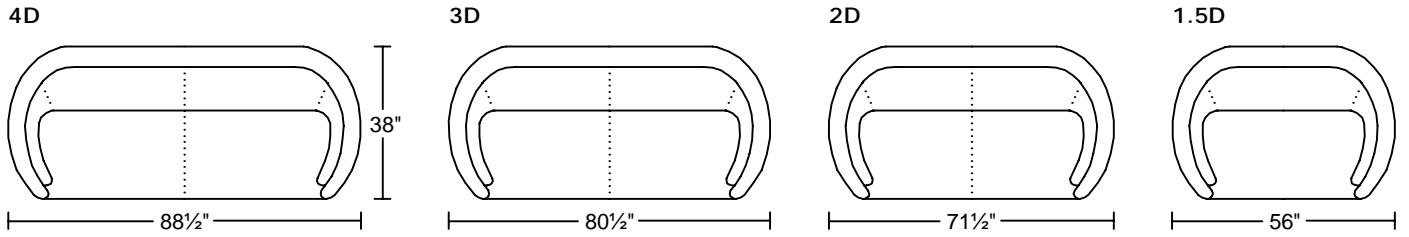

# RUSCO I 0105

## Designed for KELVIN GIORMANI

4BR/LAF

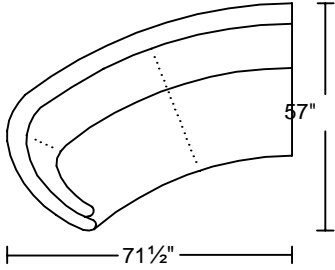

4BL/RAF

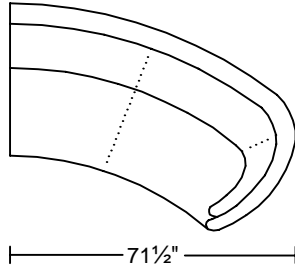

3DR3

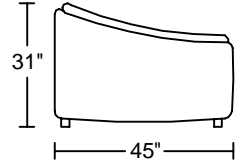
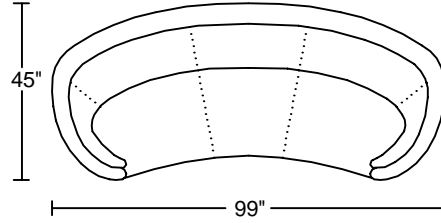

3BR/LAF

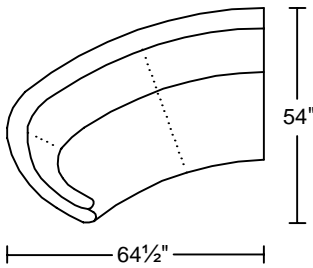

3BL/RAF

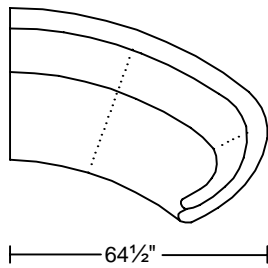

3NR

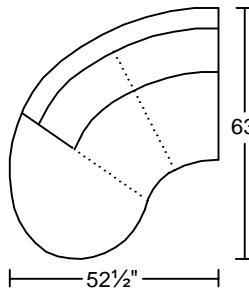

3NL

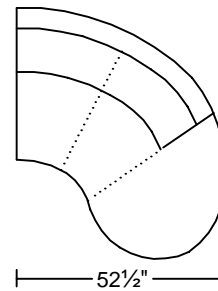

CN

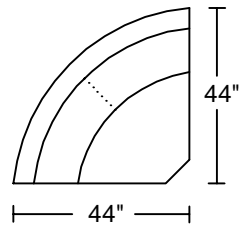

ST2

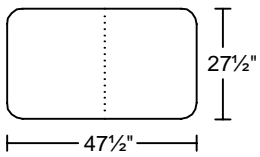

ST2

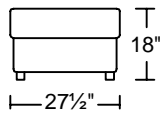

ST

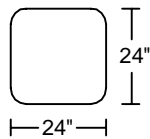

ST

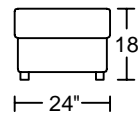

1.5CR

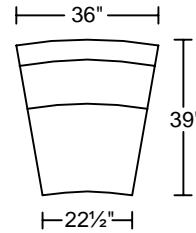

1CR

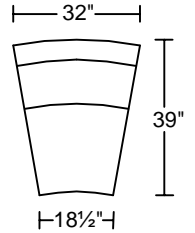

RT3

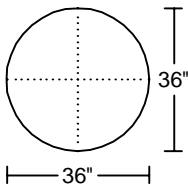

RT3

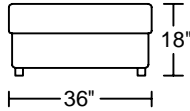

RT2

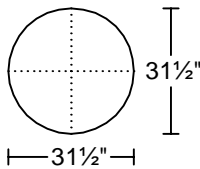

RT2

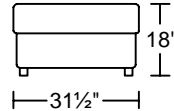

STG3  
STW3

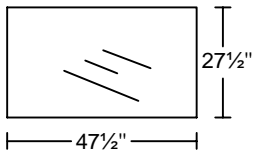

STG3  
STW3

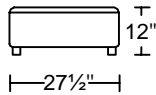

HR

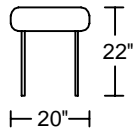

RT4L

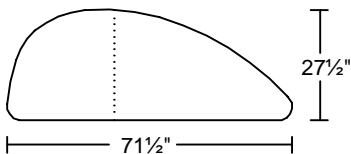

RT4R

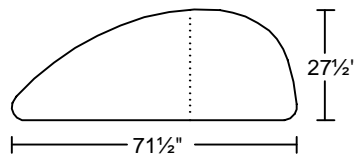

RT4L/RT4R

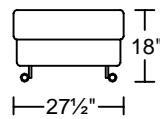

RT5L

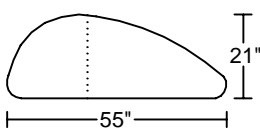

RT5R

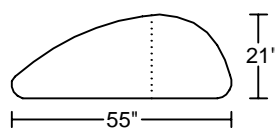

RT5L/RT5R

