

DUE 0209

Designed for KELVIN GIORMANI

4D

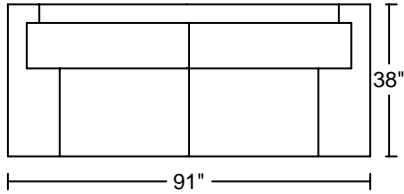
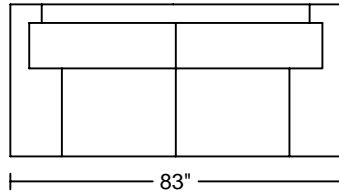

3D



2.5D

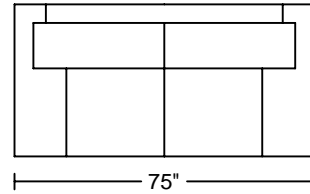

1.5D

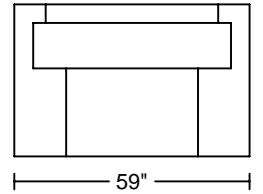

1D

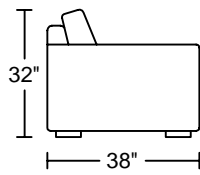
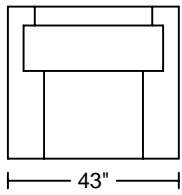

4RA/LAF

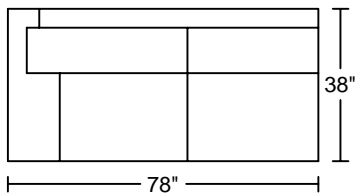

3RA/LAF

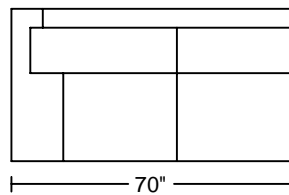

2.5RA/LAF

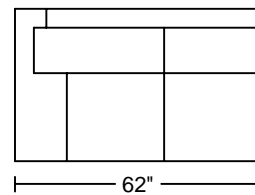

1.5RA/LAF

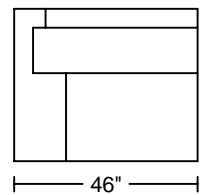

4LA/RAF

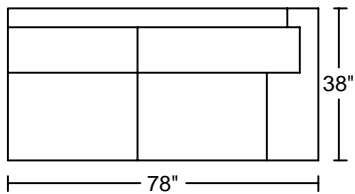

3LA/RAF

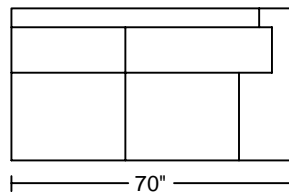

2.5LA/RAF

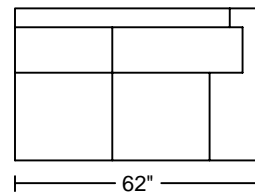

1.5LA/RAF

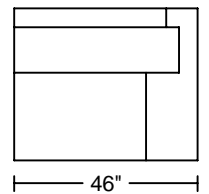

4C

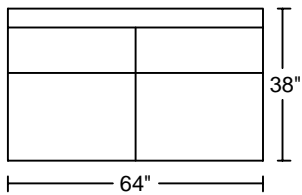

3C

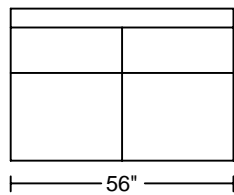

2.5C

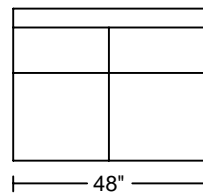

1.5C

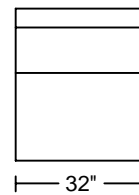

1C

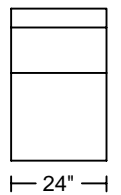

LXR/LAF

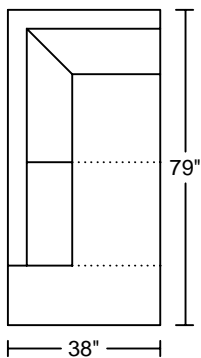

LXL/RAF

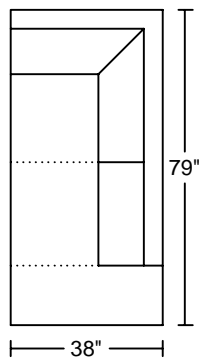

SXR/LAF

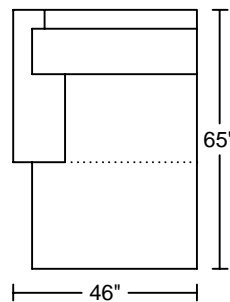

SXL/RAF

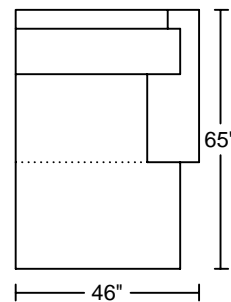

DUE 0209

Designed for KELVIN GIORMANI

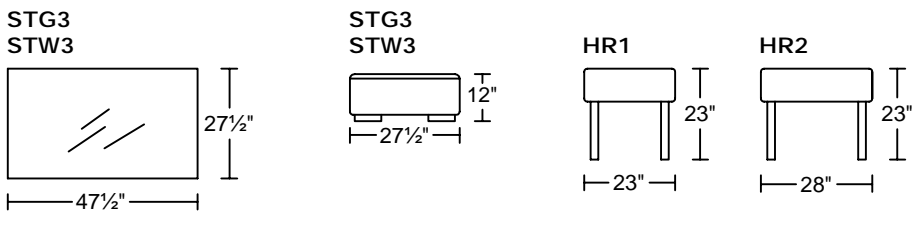
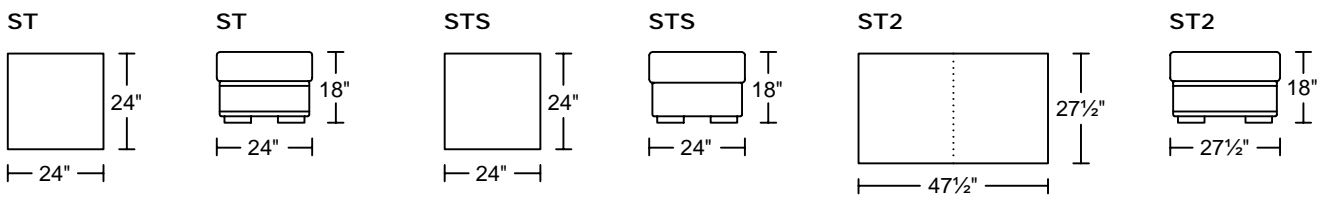
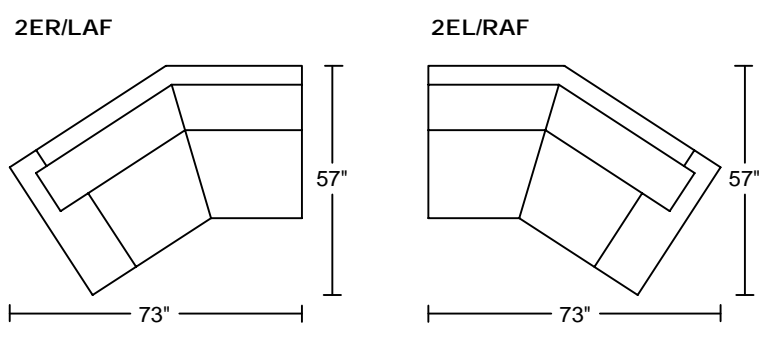
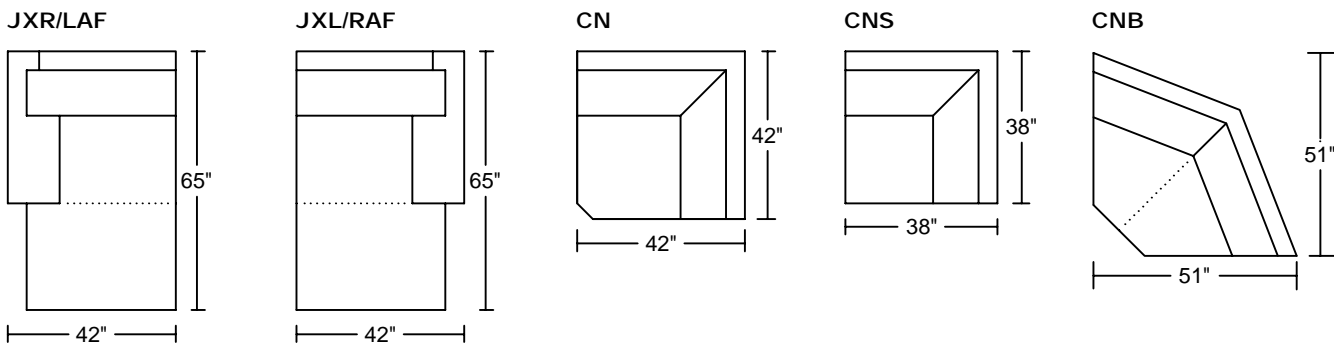

DUE 0209

Designed for KELVIN GIORMANI

4D

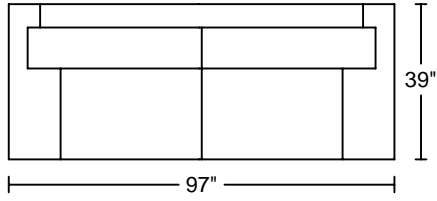

4D

