

COMODO I 0383A-M1

Designed by Kelvin Ng

4D

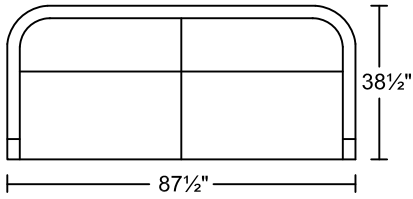

3D

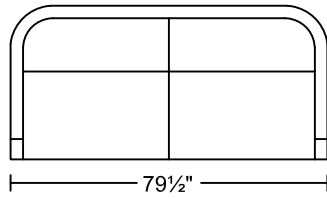

2.5D

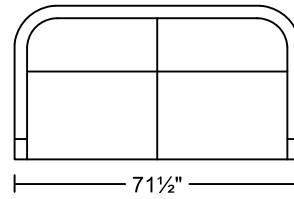

1.5D

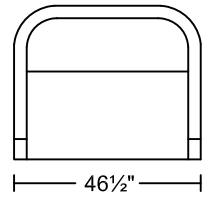

1D

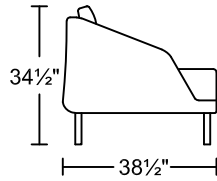
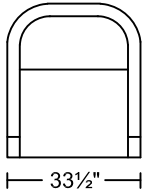

4RA/LAF

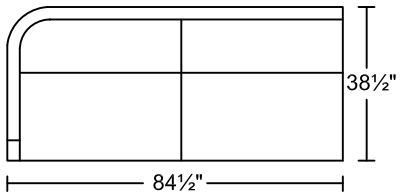

3RA/LAF

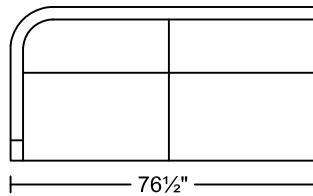

2.5RA/LAF

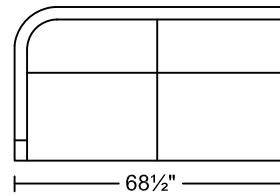

1.5RA/LAF

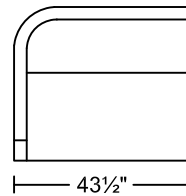

4LA/RAF

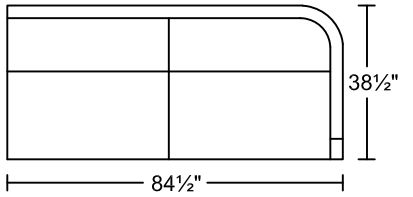

3LA/RAF

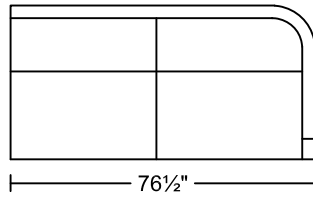

2.5LA/RAF

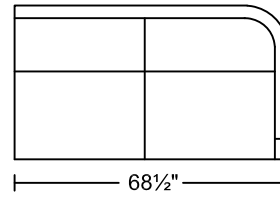

1.5LA/RAF

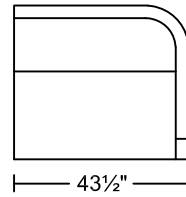

4C

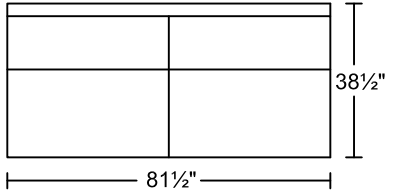

3C

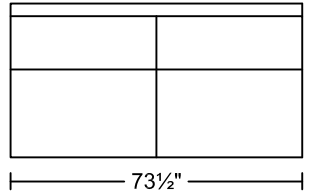

2.5C

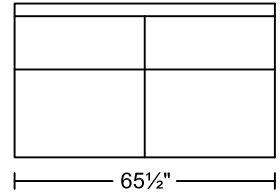

1.5C

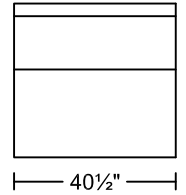

1C

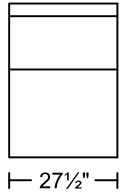

SXR/LAF

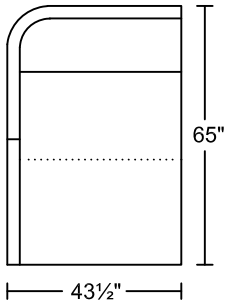

SXL/RAF

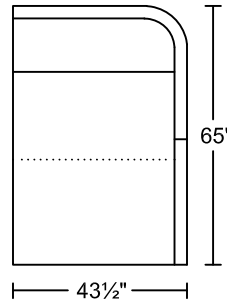

LXR/LAF

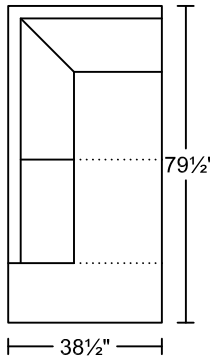

LXL/RAF

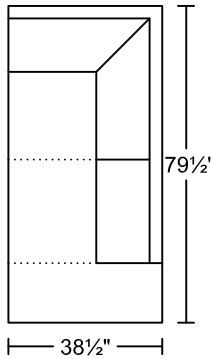

JXR/LAF

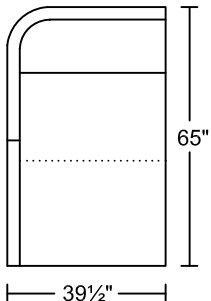

JXL/RAF

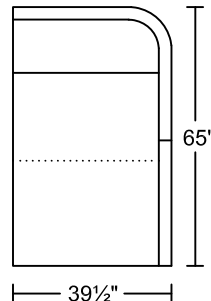

COMODO I 0383A-M1

Designed by Kelvin Ng

3BR/LAF

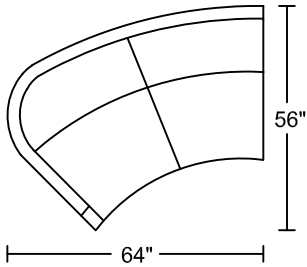

3BL/RAF

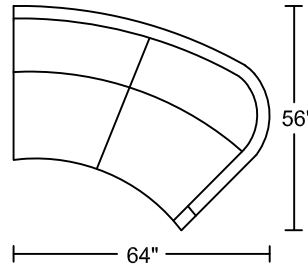

4BR/LAF

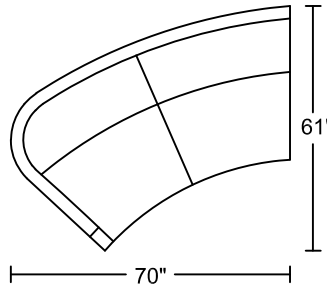

4BL/RAF

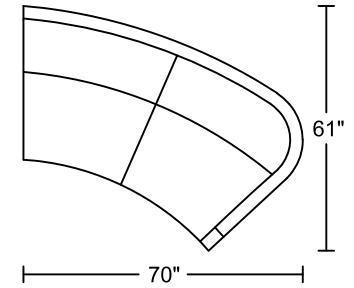

2.5UNR

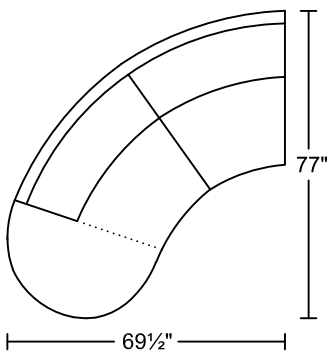

2.5UNL

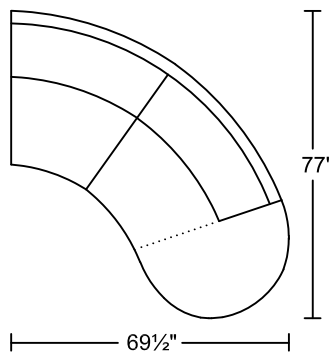

2UNR

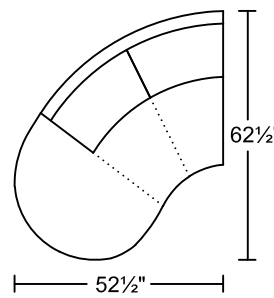

2UNL

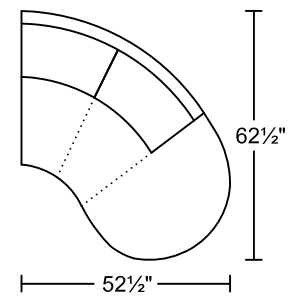

1.5CR

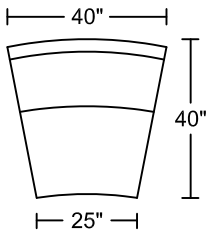

1CR

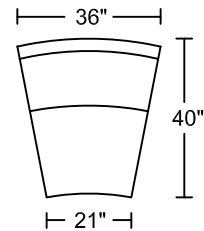

CN

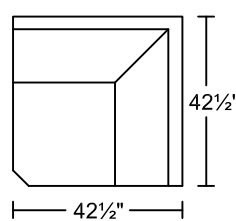

RTG1

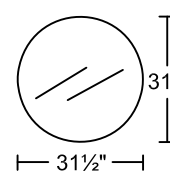

RTG1

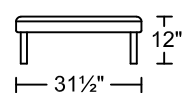

ST1

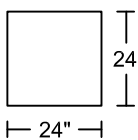

ST1

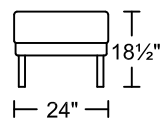

ST2

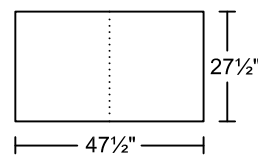

ST2

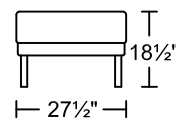

STG1

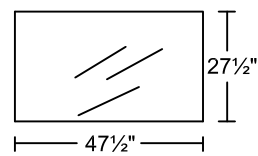

STG1

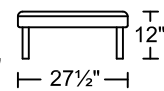

HR1

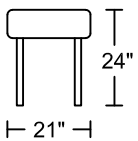

HR2

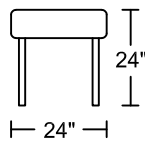

HR3

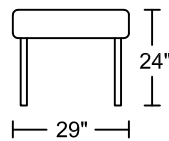

RT1

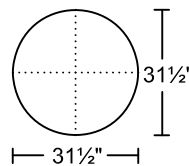

RT1

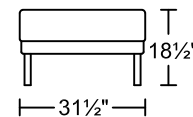

COMODO II 0383A-H1

Designed by Kelvin Ng

4D

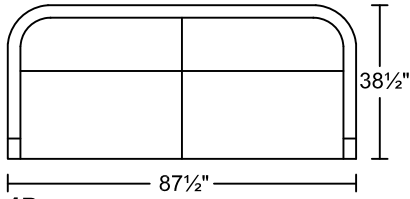

3D

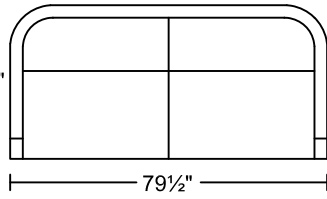

2.5D

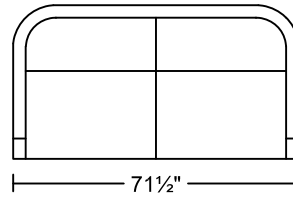

1.5D

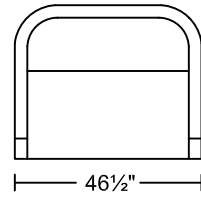

1D

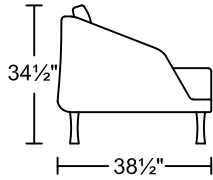
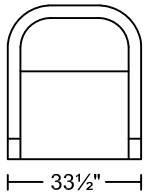

4RA/LAF

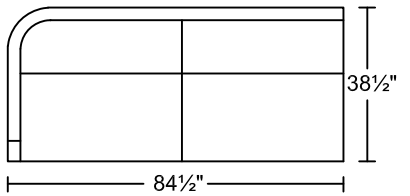

3RA/LAF

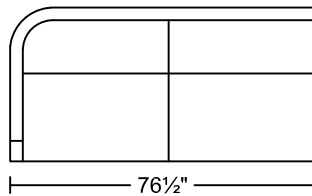

2.5RA/LAF

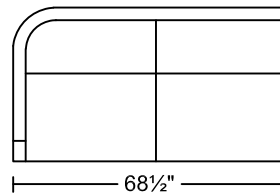

1.5RA/LAF

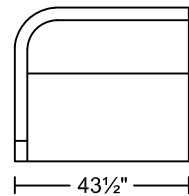

4LA/RAF

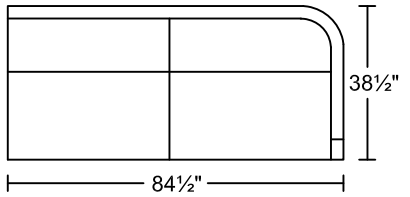

3LA/RAF

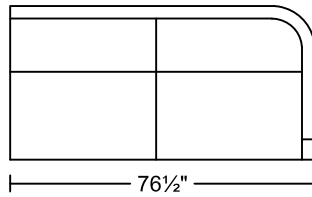

2.5LA/RAF

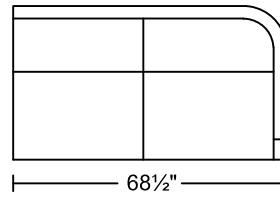

1.5LA/RAF

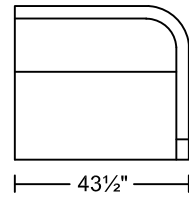

4C

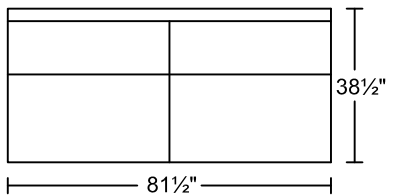

3C

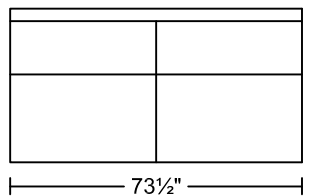

2.5C

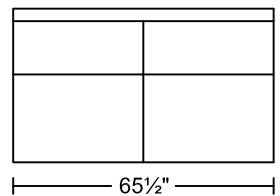

1.5C

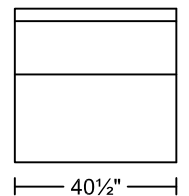

1C

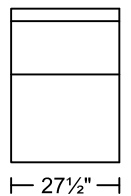

SXR/LAF

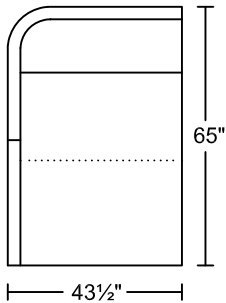

SXL/RAF

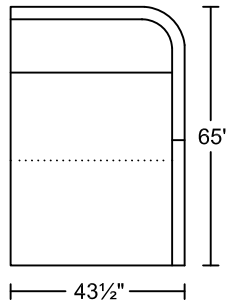

LXR/LAF

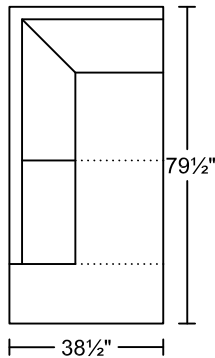

LXL/RAF

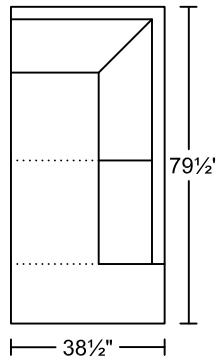

JXR/LAF

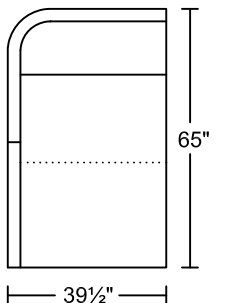

JXL/RAF

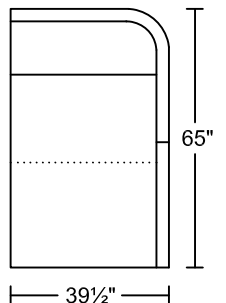

COMODO II 0383A-H1

Designed by Kelvin Ng

3BR/LAF

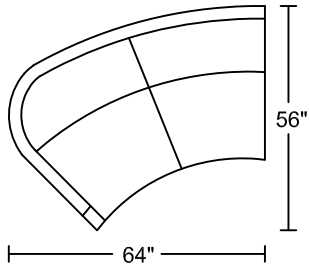

3BL/RAF

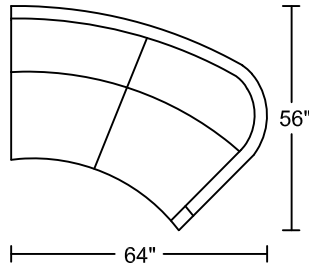

4BR/LAF

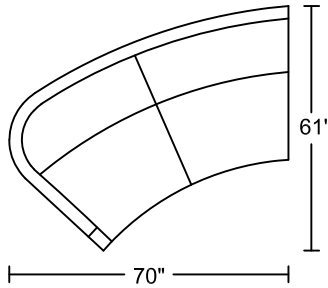

4BL/RAF

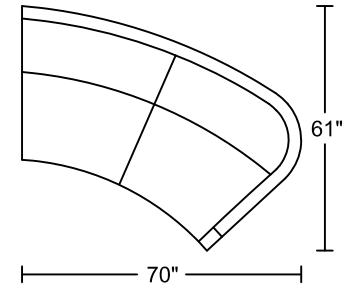

2.5UNR

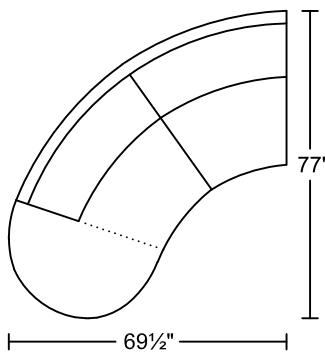

2.5UNL

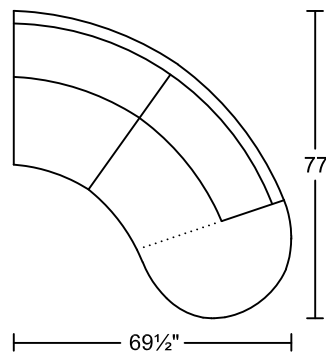

2UNR

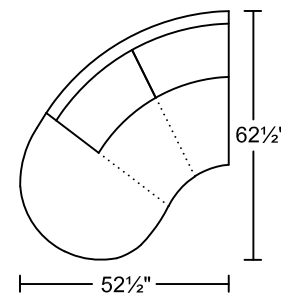

2UNL

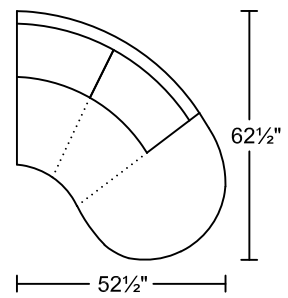

1.5CR

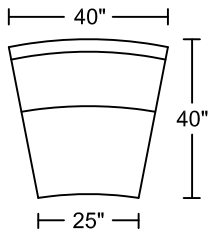

1CR

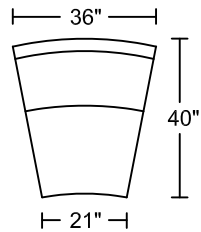

CN

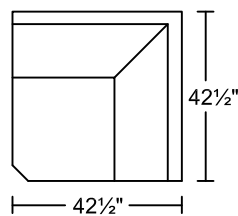

RTG1

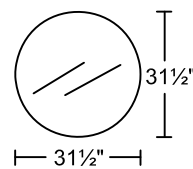

RTG1

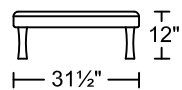

ST1

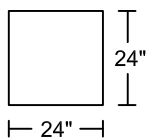

ST1

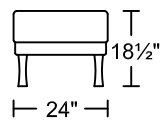

ST2

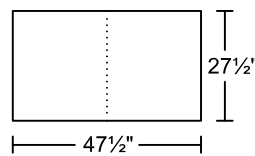

ST2

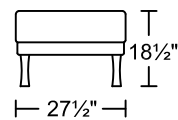

STG1

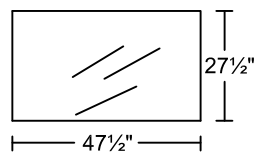

STG1

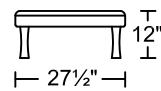

HR1

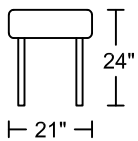

HR2

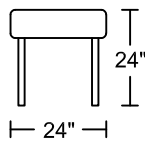

HR3

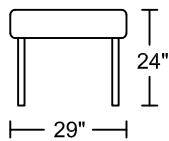

RT1

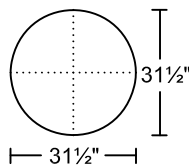

RT1

