

PLAZA I 0570A-M1
Designed by Michele Mantovani

4D

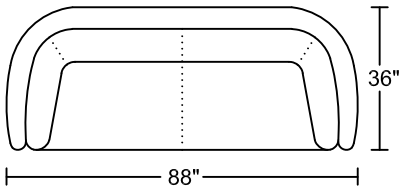

3D

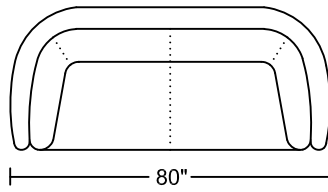

2.5D

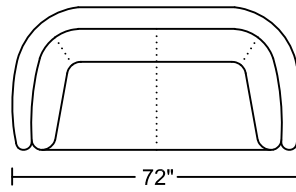

1.5D

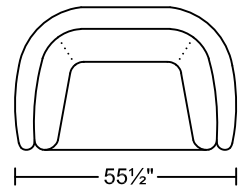

3DR3

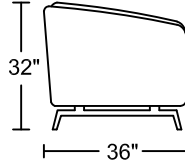
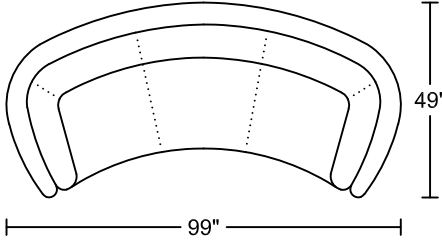

4RA/LAF

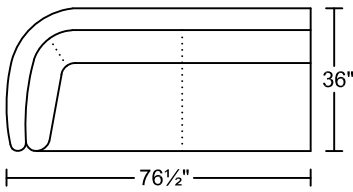

3RA/LAF

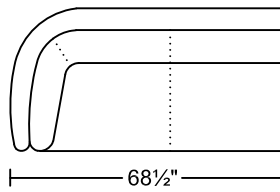

2.5RA/LAF

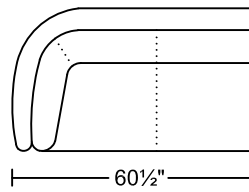

1.5RA/LAF

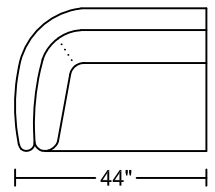

4LA/RAF

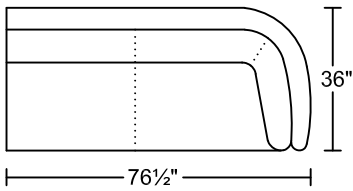

3LA/RAF

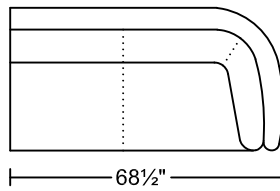

2.5LA/RAF

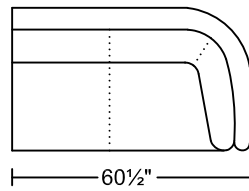

1.5LA/RAF

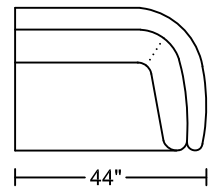

4C

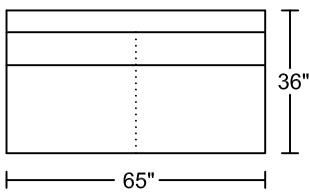

3C

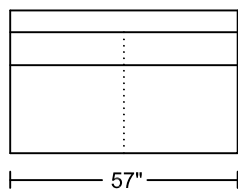

2.5C

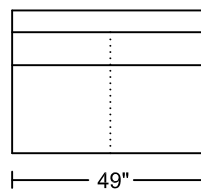

1.5C

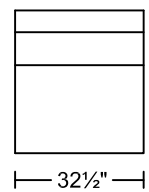

4BR/LAF

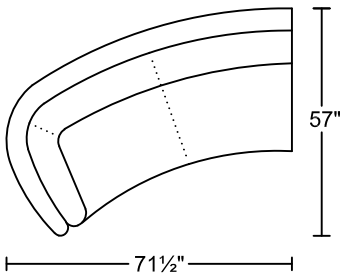

4BL/RAF

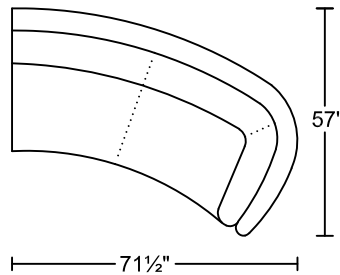

3BR/LAF

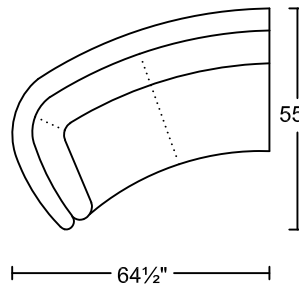

3BL/RAF

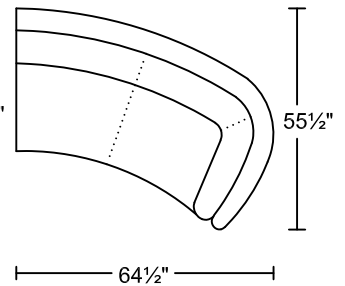

1.5BR/LAF

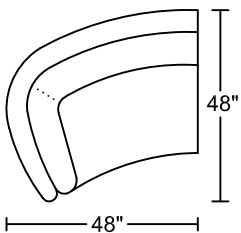

1.5BL/RAF

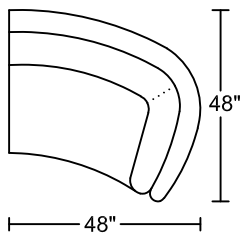

1.5CRB

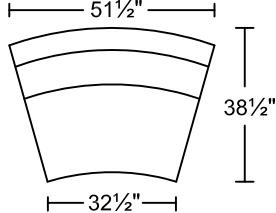

CUN

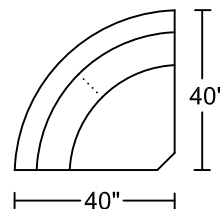

PLAZA I 0570A-M1

Designed by Michele Mantovani

SXR/LAF

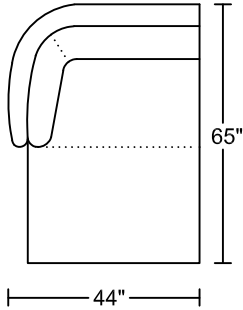

SXL/RAF

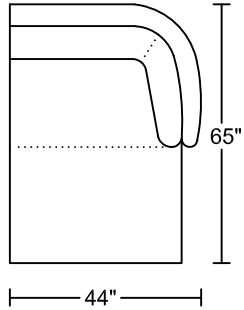

3UNR

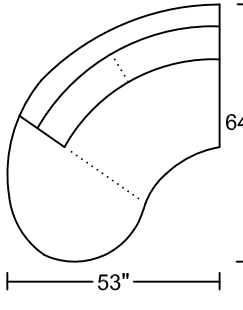

3UNL

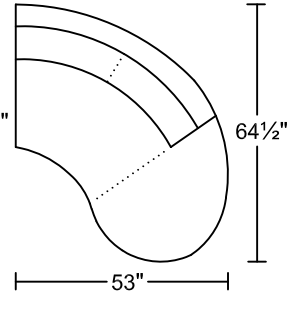

LUXR/LAF

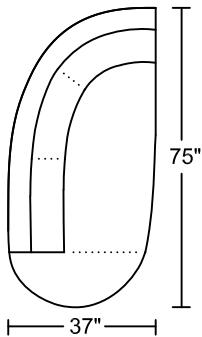

LUXL/RAF

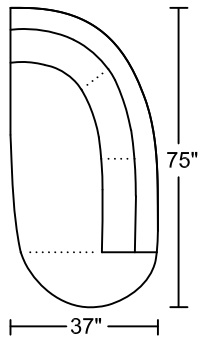

BUXRW/LAF

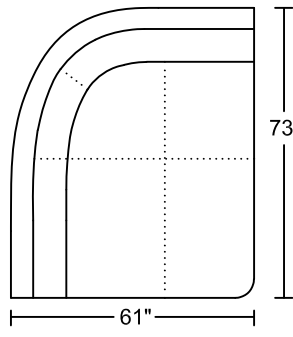

BUXLW/RAF

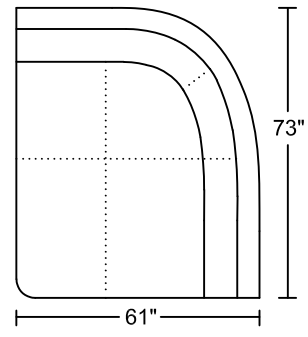

ST2

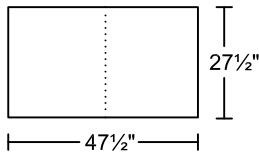

ST2

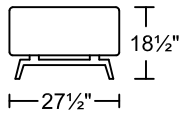

ST1

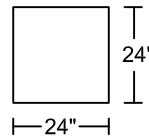

ST1

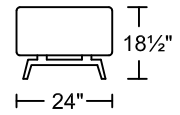

RT2

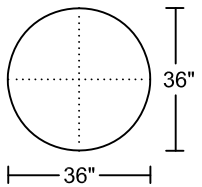

RT2

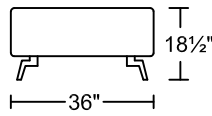

RT1

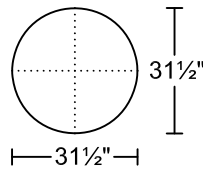

RT1

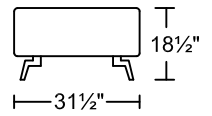

RT3

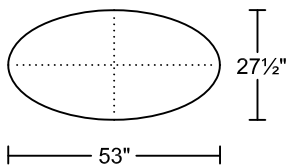

RT3

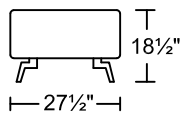

STG1

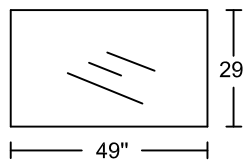

STG1

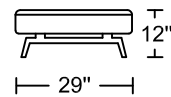

HR1

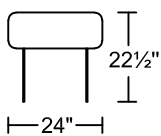

HR2

